



◀ Mine spare parts ▶



Brief Introduction of Lvssn Group

LVSSN GROUP is a technology-driven company specializing in cross-border sales of industrial products and providing comprehensive service solutions focused on the Belt and Road Initiative, Russian-speaking countries, and the Latin American market.

LVSSN has been deeply involved in the building materials industry for many years and has extensive experience in industries such as cement, steel, mining, bearings, electrical, and refractory materials. We have established close partnerships with globally renowned manufacturing suppliers, allowing us to offer a wide range of product choices while ensuring strict quality control for stable and reliable performance. Leveraging our years of experience in engineering project management, we have a dedicated technical team that provides comprehensive after-sales service and professional solutions to our clients. The strength of LVSSN lies in its integrated approach of cross-border sales of industrial products, design and development, and engineering services, offering customers a one-stop procurement solution.

LVSSN's customer base extends to dozens of countries and regions in Southeast Asia, the Middle East, Central Africa, and Central Asia. We have established deep partnerships with over 10,000 international clients and maintain long-term cooperative relationships with over 20,000 domestic advanced manufacturing suppliers. Looking ahead, LVSSN will continue to focus on its strategic goals and position cross-border B2B e-commerce as a global strategy for the company. Leveraging our brand operations and design and development capabilities, we aim to further strengthen our position and industry advantage.



Dewatering screen

Coal slime dewatering screen



High frequency dewatering screen



The main function is dewatering, desliming, and disintermediation. Dewatering screen can be used for sand washing in sand and gravel plants, coal slurry recovery in coal preparation plants, and dry tailings in concentrators, so it is also called sand dewatering screen, mine dewatering screen, and slime dewatering. Screens, dry tailings screens, high-frequency dehydration screens, etc.

➤ Main Spare Parts

Base water tank



Composite rubber spring



Vibration exciter



Vibration motor



Hydrocyclone



Screen plate, vibration exciter, slurry pump, water tank, spring, eccentric block, etc.



Rod Vibrating Feeder

GZT Rod Vibrating Feeder

ZSW Rod Vibrating Feeder

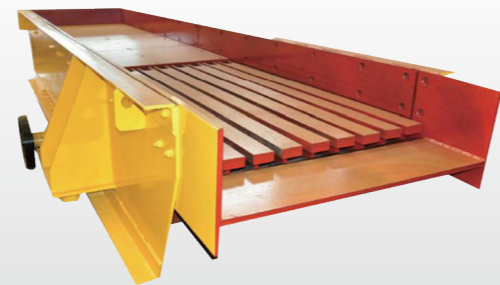

Rod vibrating feeder is used for quantitative or continuous supply of lump and granular materials, and can be used for coarse screening of materials. It is widely used in the crushing and screening combined equipment of metallurgy, coal mine, mineral processing, building materials, chemical industry, abrasives and other industries.

➤ Main Spare Parts

Vibration exciter



Screw



Eccentric shaft



Rubber spring



Vibration motor



Eccentric shafts, gears, bearings, springs, grate plates, vibration exciters, motors, etc.



Electromagnetic Vibrating Feeder

DZ Motor Vibration Feeder

GZF Series Electromagnetic Vibrating Feeder

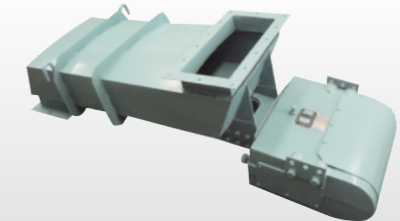

GZ Series Electromagnetic Vibrating Feeder

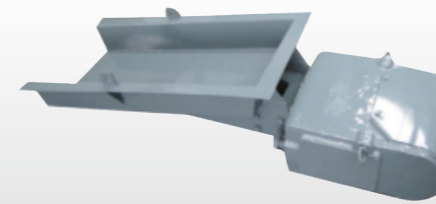

Electromagnetic vibrating feeder is used for quantitative or continuous supply of lump, granular or powder materials. It is widely used in mining, metallurgy, coal, electric power, chemical, food, glass, refractory and other industries.

➤ Main Spare Parts

Magnet

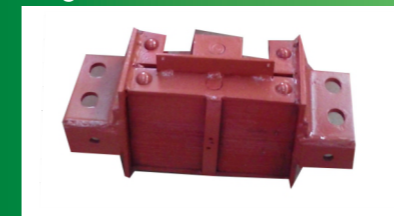

Boom



Hanger

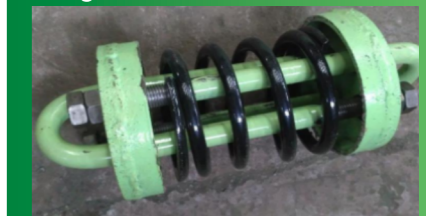

Armature



Coil



Material trough, shock absorber, electromagnet, coil, armature, spring, hanger, etc.



Hammer Crusher

Heavy Hammer Crusher



Single-stage Hammer Crusher



Hammer crusher is a kind of equipment for crushing materials in the form of impact. It is divided into two types: single rotor and double rotor. It is a one-stage crusher that directly crushes materials with a maximum particle size of 600-1800 mm to 25 or below 25 mm. The hammer crusher is suitable for crushing medium-hard materials such as limestone, slag, coke, coal and other materials in cement, chemical, electric power, metallurgy and other industrial sectors.

➤ Main Spare Parts

Grate



Hammer



Wear-resistant liner



Main shaft



Rotor



Hammer, rotor, main shaft, liner, impact plate, grate screen, belt pulley, hammer plate, liner bolt, pin, frame, etc.



Jaw Crusher

C6X Jaw Crusher



PE Jaw Crusher



The crushing chamber is composed of two jaw plates, a movable jaw and a fixed jaw, which simulates the movement of the animal's jaws to complete the material crushing operation. It is widely used in the crushing of various ores and bulk materials in mining and smelting, building materials, highways, railways, water conservancy and chemical industries. It is mainly used for coarse crushing and medium crushing. The highest compressive strength of the crushed material is 320Mpa.

➤ Main Spare Parts

Movable jaw plate oblique iron



Fixed jaw plate

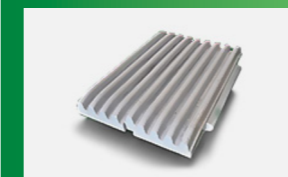

Spring



Pulley



Cylinder



Bearing



Side guard plate



Flywheel, adjusting rod, spring, movable jaw, toggle plate, plate pad, side plate, fixed plate, adjusting housing, eccentric shaft, frame, electric control parts, etc.



HGT Rotary Crusher

HGT Rotary Crusher



HGT rotary crusher integrates mechanical, hydraulic, electrical, automation, intelligent control and other technologies. It is a new type of coarse crushing equipment with large production capacity, high efficiency and Intellectualization. It has the characteristics of super large processing capacity, high efficiency and large feeding cavity, integrated moving cone, high precision eccentric copper sleeve, multi-point temperature and speed monitoring, intelligent automatic control and so on.

➤ Main Spare Parts

Liner

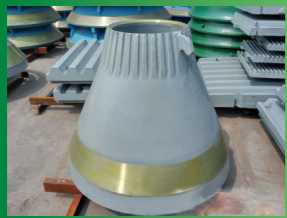

Moving cone



Steel sleeve



Cross beam



Copper sleeve



Main shaft



Moving cone, lining liner, cross beam, copper sleeve, main shaft, steel sleeve, bearing shell, sealing ring, upper and lower frame body, reducer, oil pump, etc.



Cone Crusher

CS Spring Cone Crusher

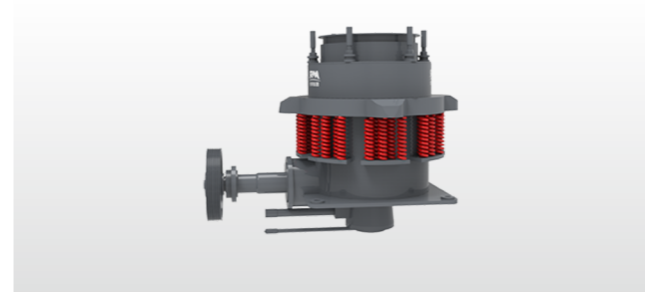

HPT Multi-cylinder Hydraulic Cone Crusher



HST Single-cylinder Hydraulic Cone Crusher



Cone crusher is widely used in mining, smelting, building materials, highway, railway, water conservancy and chemical industry. It has high crushing ratio, high efficiency, low energy consumption, uniform particle size. It is suitable for medium crushing and fine crushing of various ores, rocks, slag, refractories, etc.

➤ Main Spare Parts

Single-cylinder cone crusher-oil baffle



Single-cylinder cone crusher-steel sleeve

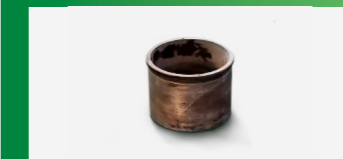

Single-cylinder cone crusher-frame liner bushing

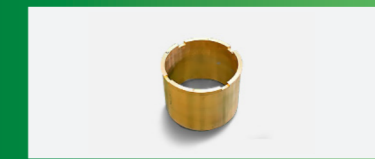

Single-cylinder cone crusher-crushing wall(s)



Single-cylinder cone crusher-crushing wall

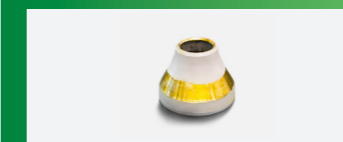

Frame, horizontal shaft, moving cone, balance wheel, eccentric sleeve, upper crushing wall (fixed cone), lower crushing wall (moving cone), fluid coupling, lubrication system, hydraulic system, etc.



Impact Crusher

CI5X Impact Crusher

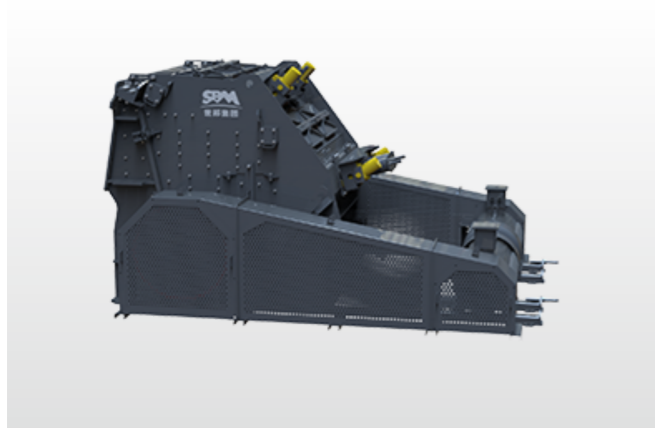



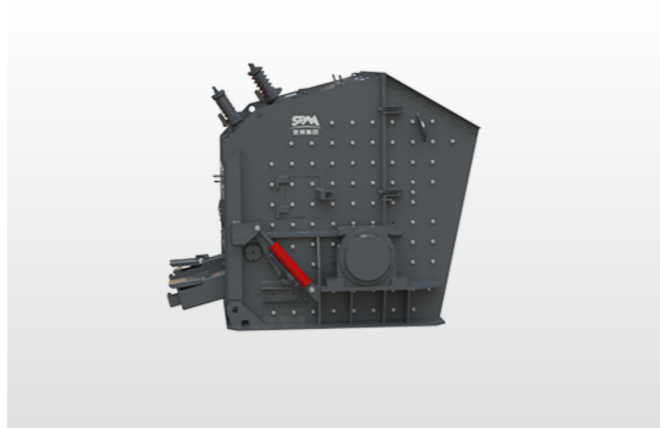



PFW Impact Crusher

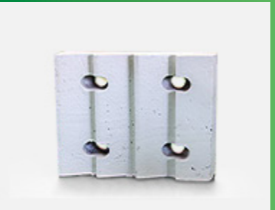

The impact crusher can process materials with a side length of 100-500 mm, with a pressure resistance of up to 350 MPa, and has the advantages of large crushing ratio and cubic particles after crushing. It is widely used in building materials, transportation, energy, cement, mining, chemical industry and other industries to finely crush materials. The discharging particle size can be adjusted, and the crushing specifications are diversified.

➤ Main Spare Parts

<p>Plate hammer</p> 	<p>Liner</p> 	<p>Big impacting plate</p> 	<p>Bolt</p> 
<p>Cooper sleeve</p> 	<p>Small impacting plate</p> 	<p>Springs, railings, front impacting frame, back impacting frame, impacting liner, square steel, impact liner bolts, flip device, main shaft, plate hammer, rotor frame, liner, locking block, compression block, etc.</p>	



Vertical Shaft Crusher

VSI

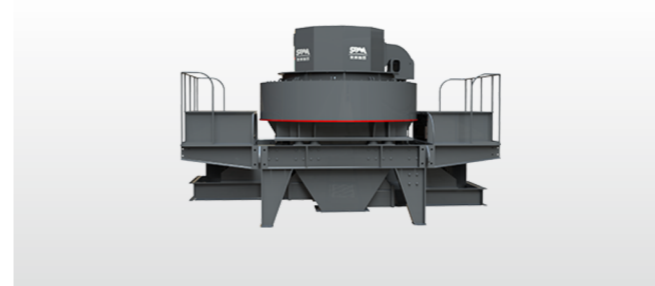

VSI6X

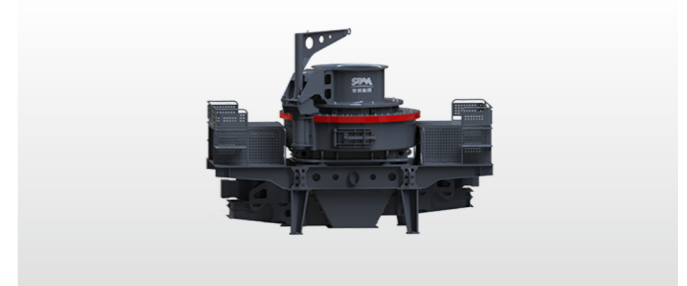

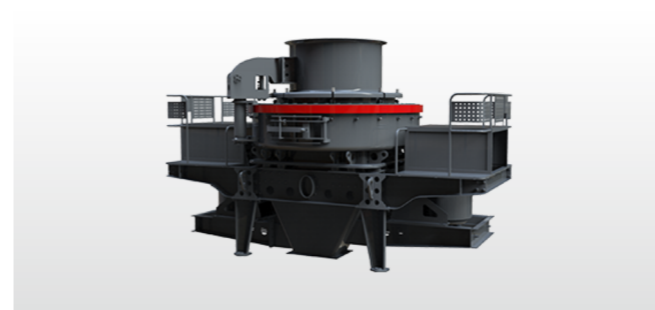

VSI5X



The vertical shaft impact crusher was applied in the 1980s and has the characteristics of stable and reliable work, convenient maintenance, and high sand production rate. It is especially suitable for stone shaping and production of machine-made sand, and can be widely used in fine crushing operations in hydropower, highway, construction, cement, metal mining and other industries.

➤ Main Spare Parts

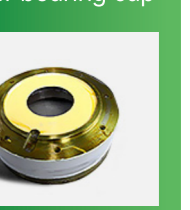
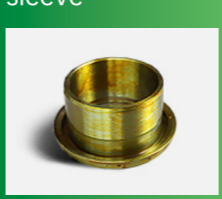
<p>5X hammer</p> 	<p>5X distributor</p> 	<p>Distributor</p> 	<p>Upper impact guard plate</p> 	<p>Upper bearing cap</p> 
<p>Lower sealing sleeve</p> 	<p>Hopper lining ring</p> 	<p>Runner plate, distributor hammer, wear plate, peripheral guard plate, impact guard plate, impact block, lining ring, bearing cap, sealing sleeve, etc.</p>		



Vibrating Screen

YZS Vibrating Screen

YKN Vibrating Screen



Vibrating screen is widely used for classification operations in coal, metallurgy, hydropower, mining, building materials, chemical, electric power, transportation, ports and other industries. It is mainly divided into linear vibrating screen, circular vibrating screen, high-frequency vibrating screen, etc.

➤ Main Spare Parts

Bar screen plate



Woven screen meshe



Bouncing rod screen plate



Flange type vibration exciter

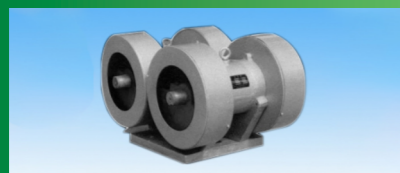

Ring groove rivet



Screen plates, screen meshes, hoop plates, springs, vibration exciters, bearings, silicone balls, seals, grid combinations, beam rings, etc.



Sand Washer

Wheel Sand Washer

Spiral Sand Washer

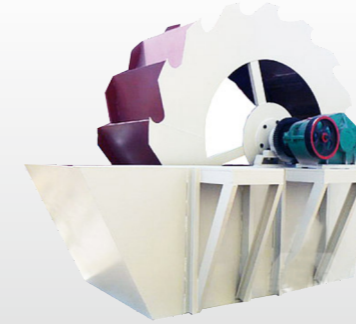

Sand washer is widely used in the washing of materials in industries such as sand quarry, mines, building materials, transportation, chemical industry, water conservancy and hydropower, concrete mixing plants, etc. It can remove impurities covering the surface of sand and stone, and at the same time destroy the water vapor layer that covers the sand. It is conducive to dehydration and play a role in efficient sand washing and cleaning. The common ones are wheel sand washer and spiral sand washer.

➤ Main Spare Parts

Gear



Big gear ring



Coupling



Bucket



Bearing



Buckets, blades, gears, bearings, castings, etc.